

# Introduction to VISTA VIEW™



# **Contents**

Introduction to .....	1
1.Mesh and Colors .....	3
2. Applications.....	4
3. Configurations.....	4
4. Features .....	6
5. Housing Sizes.....	6
6. Maximum Opening Dimensions.....	6
7. Mounting.....	7
8. Fastening.....	8
9. Recessed Option .....	9

VistaView wall screens are thoughtfully designed to provide a contemporary look, be simplistic in use, and ensure reliable, superior performance.

## 1.Mesh and Colors

Wizard offers a wide range of specialty mesh that suits the customers needs.

The beauty of the customer's panoramic view is maintained with the pleat-less mesh Wizard uses in all of our systems.



Colors are custom formulated for Wizard by Akzo Nobel - optional custom finishes and RAL colors are also available.

## 2. Applications

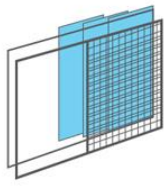

Multi - Sliding Doors

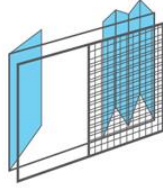

Bi-Fold Doors

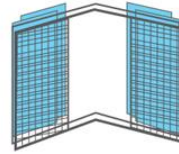

Corner Openings

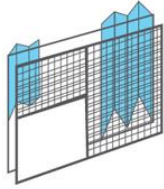

Split Height

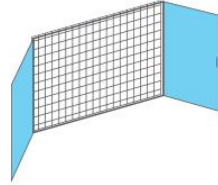

French Doors

## 3. Configurations

*Double screens* can be **50:50 splits**. They can also be **off-center splits**. This means that the tracks **do not** have to be cut to meet in the center. The screen can also extend to either end.

**!Tip - Pull-bars stop at the track joiners.**

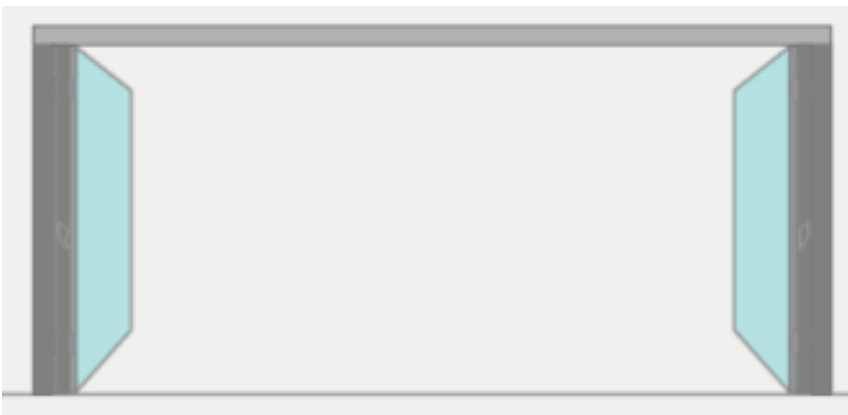

**90° Corners** are possible in post-less openings.

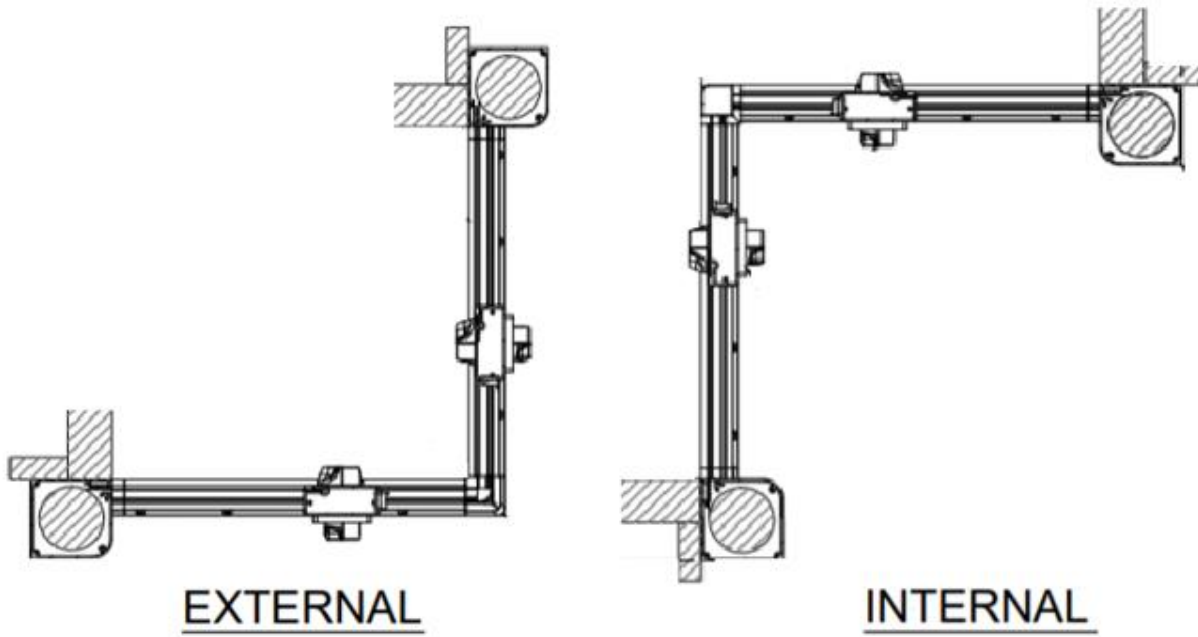

Internal Corner



**\*Note** - the handles at different heights.

## 4. Features



### **Auto-Stop**

Homeowners gain full control with the convenience of unlimited stopping points. Automatically stops when the handle is released.

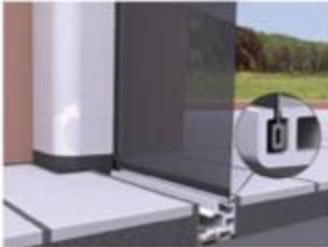

### **Captured Mesh**

A zipper welded to the mesh keeps the screen tight, prevents blow-outs and gives strength to withstand high winds.



### **Recessed Track**

VistaView screens can be recessed to provide a smooth transition and finished look.

## 5. Housing Sizes

- 60mm (2 3/8")
- 70mm (2 3/4")
- 80mm (3 1/8")

## 6. Maximum Opening Dimensions

	Single (W x H)	Double (W x H)
60 mm	6' x 11'	12' x 11'
70 mm	10' x 10'	20' x 10'
80 mm	14' 6" x 11'	29' x 11'

## 7. Mounting

The VistaView can be either (1) surface or (2) under-header/in-jamb mounted.



## 8. Fastening

### Housing

VistaView *housings* can be fastened through the front, back, or inside locations.

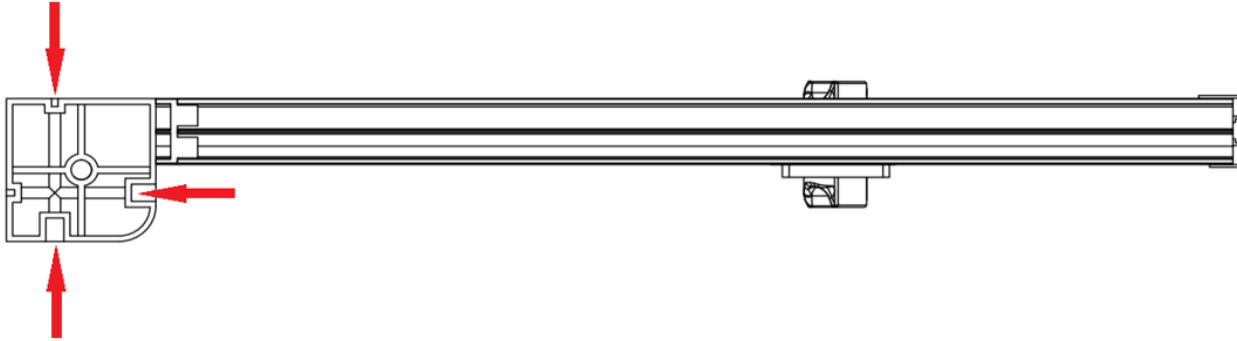

### Tracks

*Upper & Lower Tracks* are identical.

*Tracks* can be fastened vertically or horizontally to suit install.

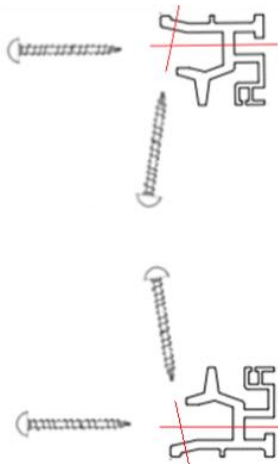



## 9. Recessed Option

*Lower tracks and lower housing endcap can be recessed into a channel and cup.*

