

SmartScreen Motorized Standard Comprehensive Guide

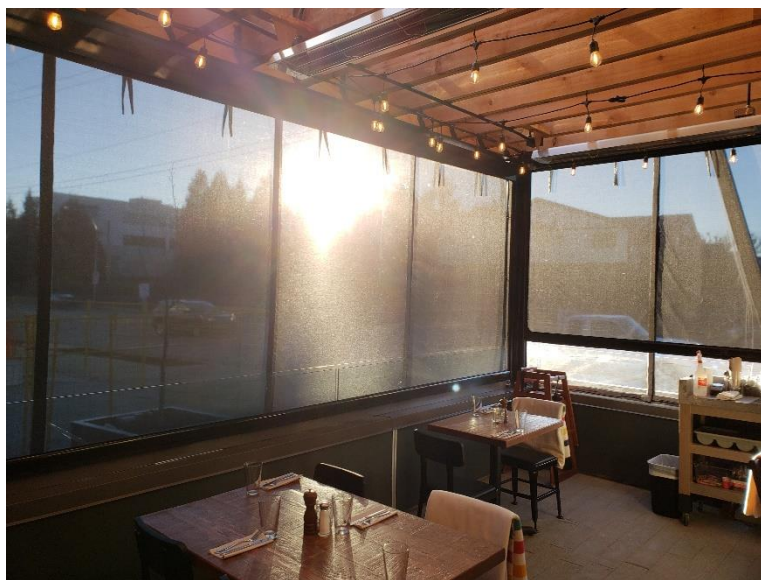

Contents

Recommendations & Resources	3
Preliminary Planning	4
Measurements	6
Ordering Process	9
Field Preparation	12
Installation	14
1) REVEAL FIT accessories	14
2) Install housing back	14
3) Install rolled screen	15
4) Somfy Maestria 500 Series Motor programming	16
5) Install bottom-bar	17
6) Affix tracks	18
7) Fine-tune screen limits	20
8) Route Cord and Re-attach Plug	21
9) Finishing Touches	22

Recommendations & Resources

1. Read these instructions before first installation.
2. Bookmark these instructions and print copies to have on hand.

Technical info

www.wizardscreens.com/technical in “SmartScreen Motorized” table

3. Learn about the **Somfy Maestria 500 motor**

Download the Help me app



Integration guide: <https://snabatools.com/integration-configurator>

Quick guide: [Maestria Quick Visual Guide 10-2018.pdf](http://wizardscreens.com/Maestria%20Quick%20Visual%20Guide%2010-2018.pdf)
(wizardscreens.com)

Video: [Maestria Quick Guide - Manual Limit Adjustment](#)

Training Portal: https://www.somfy.com/users/sign_up

DO NOT PROCEED WITH INSTALLATION BEFORE COMPLETING THE ABOVE.

4. Call **1-888-949-3667**
 - a. to schedule an installation training session if deemed necessary
 - b. if problems arise during installation
5. Wizard Ordering Portal
<https://portal.wizardscreens.com/>

Preliminary Planning

- Min. width = 38"
- Max. width = 30'
- Max. width (vinyl) = 25'
- Max. height = 16'

1) Determine the installation type.

a) **Reveal Fit** - Unit mounted under header and inside jambs.

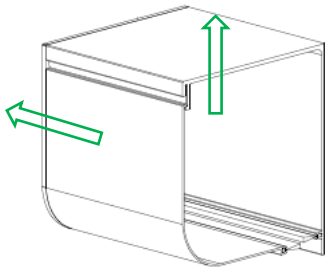

Tracks mounted to:

i) 2"x2" Angle Channels

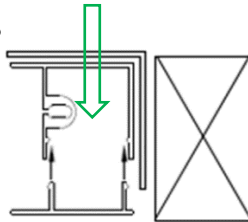
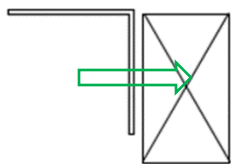

OR

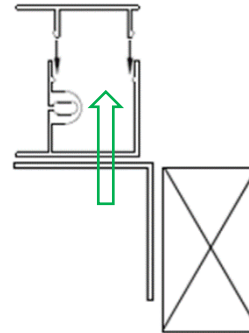

ii) 2"x1" Box Channel



b) **Face Fit** - Unit mounted onto faces of header and jambs.

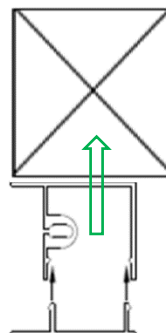
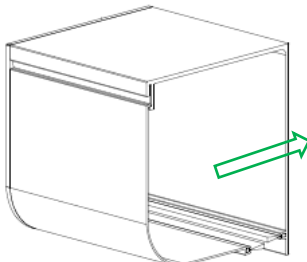

***NOTE:** Combination possible as installer sees fit.

2) Component & Sizing Table

Selectable					Dimensional Threshold	
Screen Material	Roll-tube	Housing	Motor	Idler	Width	Height
Any (excl. vinyl)	4"	5 ½"	Maestria 525	Standard 2 1/8"	38" to 22'4"	& less than 12'
Any (excl. vinyl)	5 ¾"	7"	Maestria 550	Double 7 ¼"	22'4" to 30'	& 12' to 16'
Vinyl	See "Dim. Thresh."		Maestria 550	See "Dim. Thresh."	38" to 25'	Up to 16'

***NOTE: If size is *beyond* threshold in first row, some/all of first row items will *not* be selectable.**

For more details, see step 5 "ORDERING PROCESS"

3) Graded floor (I.e., sloped patio)

- a) It can be requested the screen be cut at the bottom to a **maximum 1 ½" grade.**
- b) Mohair can accommodate an **extra 1" grade.**

*****HOUSING MUST BE LEVEL!**

Measurements

1) Tools required:

Tape Measure

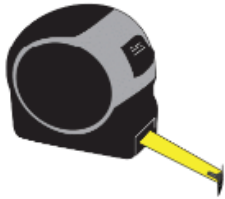

Pencil



2-way Laser Level Kit



Laser Distance Measure



2) Establish **plumb** and **level** marks. Then determine dimensions.

* The industry standard “3-width-measurements method” will *not* work **most effectively** for most cases.

****Unit must be *measured for* and *established* plumb, level, parallel, and square. It is likely the opening will *not* have all of these attributes. For in-jamb fit applications, it is especially important to *not* measure a unit's width too large.**

The “opening” illustrations are *exaggerated* to provide clarity.

 = opening

 = future screen

In-Jamb Fit

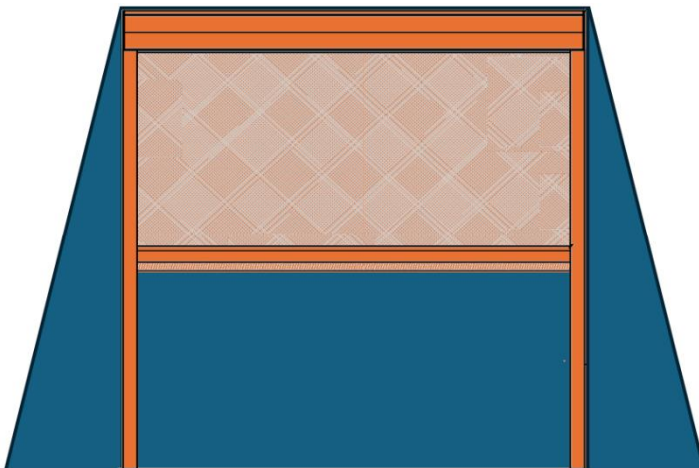

Face Fit

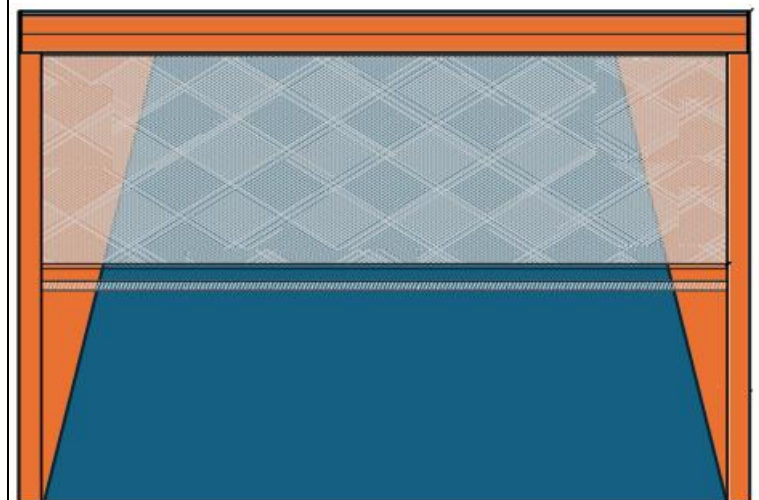

In-Jamb Fit

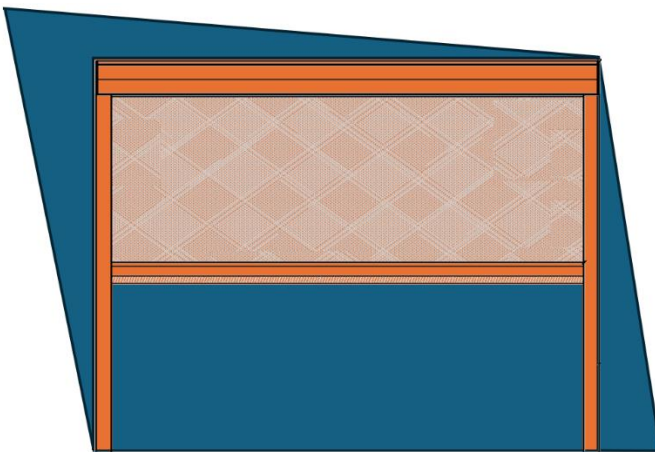
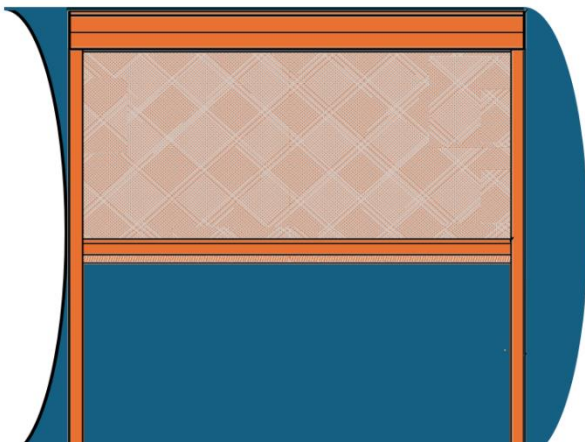
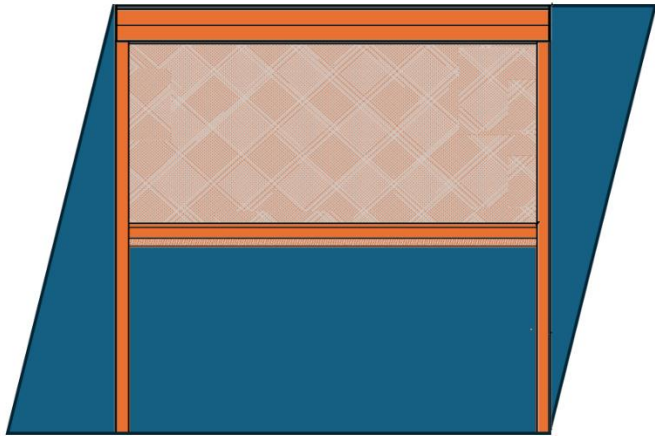

Face Fit

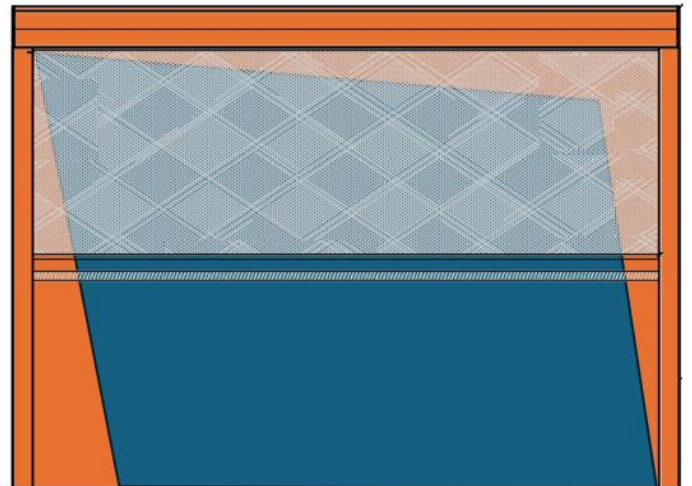
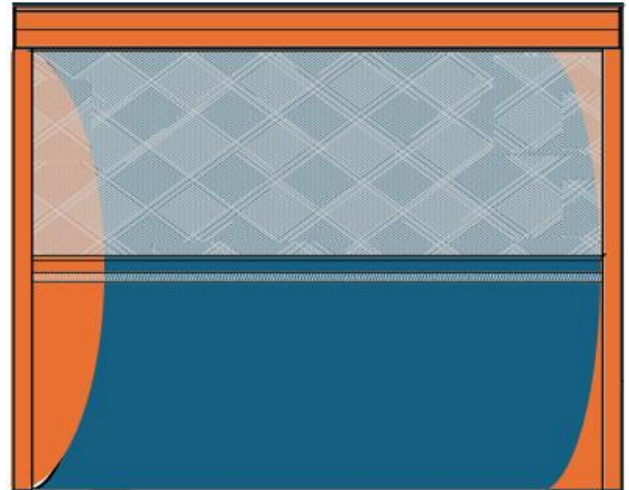
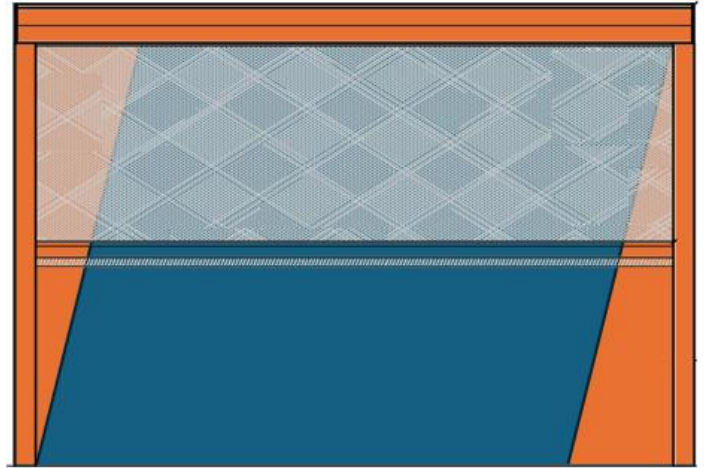

3) Deductions & Additions

a) In-Jamb Fit - Width

- i. 2"x2" Angle Channel
 $\frac{1}{8}" + \frac{1}{8}"$ Angles thickness
 $+\frac{1}{8}"$ Safety
 $= -\frac{3}{8}"$ **Width Deduction**



- ii. 2"x1" Box Channel
 $\frac{1}{8}"$ Safety
 $-\frac{1}{8}"$ **Width Deduction**



b) Face Fit - Width

- i. Tracks
 $1\frac{7}{8}" + 1\frac{7}{8}"$ Track Widths
 $\approx +4"$ **Width Addition**

c) Height

- i. Record **largest** height measurement from **top of future-housing to floor**.
- ii. If floor is *graded*, measure from **top of future housing to floor** at *left* and *right* sides. Record both measurements.
 - * It can be requested the screen be cut at the bottom to a **maximum 1 ½" grade**.
 - **Mohair can accommodate an **extra 1" grade**.
 - *****HOUSING MUST BE LEVEL!**

Ordering Process

1) Dimensions

Min. width	= 38"
Max. width	= 30'
Max. width (vinyl)	= 25'
Max. height	= 16'

2) Colors of components

*Latest offerings [Screens for Doors, Patio, Window, Deck Spaces - Built Better | Wizard Screens](#)

3) Bottom-bar Seals

- Mohair
- Rubber (necessary if adding extra weight or with vinyl)

4) Screen Material

- Insect
- Solar
- Privacy
- Clear Vinyl. See "Clear Vinyl Minimum Dimensions" on [tech page](#)

*Note: Screen roll widths vary by material. Two pieces of material may need to be welded together, causing a visible seam.

Latest offerings

[Screens for Doors, Patio, Window, Deck Spaces - Built Better | Wizard Screens](#)

5) Motor

- Select side as if looking at **front** unit, imagining how it will be oriented.
- Select power cable length
 - 10'
 - 24'

*Antennae within 18" of motor end. Do not cut!

Electrical Considerations: [Somfy-Maestria-50-RTS-specs.pdf \(wizardscreens.com\)](#)

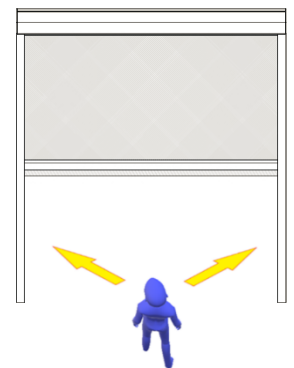

6) Component Table

Selectable					Dimensional Threshold	
Screen Material	Roll-tube	Housing	Motor	Idler	Width	Height
Any (excl. vinyl)	4"	5 ½"	Maestria 525	Standard 2 1/8"	38" to 22'4"	& less than 12'
Any (excl. vinyl)	5 ¾"	7"	Maestria 550	Double 7 ¼"	22'4" to 30'	& 12' to 16'
Vinyl	See "Dim. Thresh."		Maestria 550	See "Dim. Thresh."	38" to 25'	Up to 16'

***NOTE: If size is beyond threshold in first row, some/all of first row items will not be selectable.**

If the project has multiple openings of varied sizes, and some require the larger size unit, consider the following:

a) Retraction speed:

Assume some smaller openings only require 4" roll-tubes and some larger openings require 5 ¾" roll-tubes.

- A 4" roll-tube will retract faster than a 5 ¾" roll-tube. Order 7" housings and 5 ¾" roll-tubes for all units.

b) Aesthetics:



Assume larger openings require 7" housings and smaller openings only require 5 ½" housings.

- Order 7" housings for all units.

c) If both retraction speed and aesthetics are important with above assumptions, order 7" housing and 5 ¾" roll-tubes for all units.

7) Remotes

a) Types

- i) 1 unit = Telis 1 channel 
- ii) 1 - 5 units = Telis 5 channel 
- iii) 1 - 16 units = Telis 16 channel 

***NOTE: It's recommended an installer carries a Telis 1 channel remote.**

- b) The effectiveness of Radio Technology Somfy® (RTS) is subject to:
- i) Distance (**should be within 30'**)
 - ii) Physical obstructions (i.e., concrete, wood, drywall, windows, etc.).
 - iii) Wired and wireless devices (i.e., refrigerators, wifi extenders, etc.)
- *Multiple remotes may be necessary.

8) Optional accessories

a) **Somfy myLink™**

- i) Converts the home's Wi-Fi to RTS (Radio Technology Somfy®) that the motors can read.
- ii) Allows for control of the screen through an app on a smartphone.
- iii) Allows for third party home automation integration.

*The myLink™ must be located both **within the Wi-Fi hot zone and within 30' of the motorized screen.**



The remainder are *special requests*:

b) **Somfy Repeater**

- i) Increases remote signal distance by another 30'.

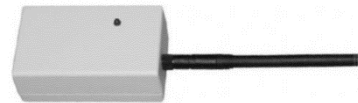

c) **Somfy Wind Control**

- i) Can detect wind at desired max. wind speed and/or intensity of sun lumas at desired max. amount.



***Note for Somfy wind and sun control options: Using these accessories can cause the screen to be in motion without it being checked for debris or damage prior to the screen being in motion, which can lead to new or further damage. Customer would have to use at own risk.**

*All SmartScreen Motorized units use Somfy Maestria 500 series motors with obstacle detection.

9) Other special requests:

- a) Seam location
- b) Accessories
- c) Extra weight (ideal for heavy fabrics and windy areas)

Field Preparation

Before installing the SmartScreen Motorized units

- 1) Tools Required:
 - a) Cordless drill
 - b) Desired driver bits
 - c) Phillips screwdriver
 - d) 2-way laser level
 - e) Tape measure
 - f) Laser distance measure
 - g) Scissors
 - h) Needle nose pliers
 - i) Duct tape (if floor is graded)
 - j) Dry silicone spray
 - k) Caulking gun with desired color caulk
 - l) Chop saw with non-ferrous blade
 - m) Concrete, metal, or wood fasteners (minimum 2" long)
 - n) Appropriate fasteners. Determine what material the components will be fastened to (e.g. lumber, metal, plywood, etc.) **Min. 2" long.**

- 2) Contents of Shipment per unit (may vary)
 - a) Assembled housing
 - b) Assembled rolled screen
 - c) Bottom-bar with seal
 - d) Probes (x2)
 - e) Tracks (x2)
 - f) Remote(s)Optional:
 - g) 2"x2" angles (x2)
 - h) 2"x1" box channels (x2)

- 3) Package and unit visual inspection
 - a) If the **packages** are damaged, the **unit may still be free of damage. No matter, you must mark the external damage on the waybill.**
 - b) Report any potential damage to Wizard Screens **immediately** with pictures.

- 4) Unpackaging
- a) Unpackage the unit and parts.
 - b) Detach housing cover. Set that and screws aside.
 - c) Remove spring ring from crown.

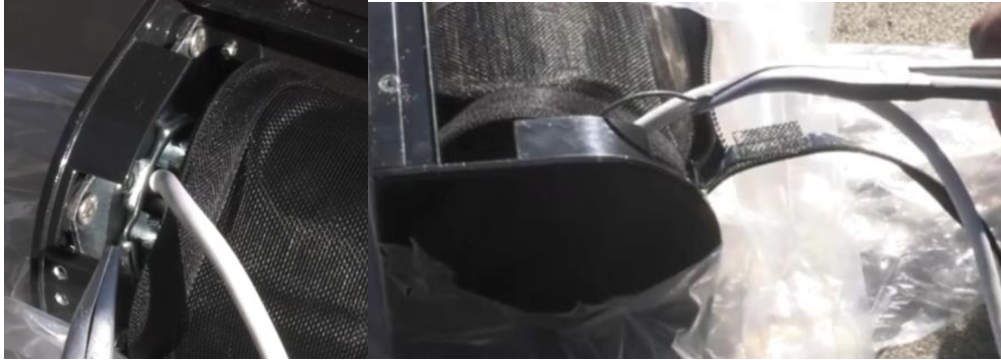

- d) Compress the pivot end until the motor end comes free from the crown and remove.

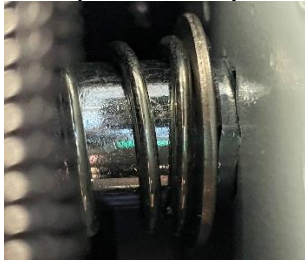

- e) Re-attach spring ring onto crown.

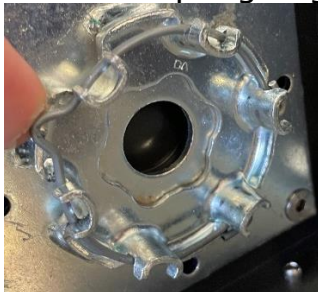

Installation

*Minimum 2 people recommended.

1) REVEAL FIT accessories

a) Install 2"x2" angle channels

i) Mark angles to desired lengths and cut.

ii) Pre-drill and countersink holes 2" from top and bottom. Then continue 48" O/C.

iii) Fasten angles to surface using flatheads, plumb front-to-back.

***EXCEPTION:** If the posts are *very* out-of-plumb side-to-side, plumb side-to-side as well.

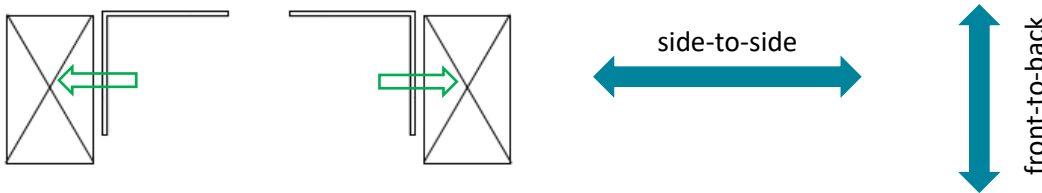

b) Install 2"x1" box channel

i) Mark box channels to desired lengths and cut.

ii) Fasten box channel to surface, plumb front-to-back.

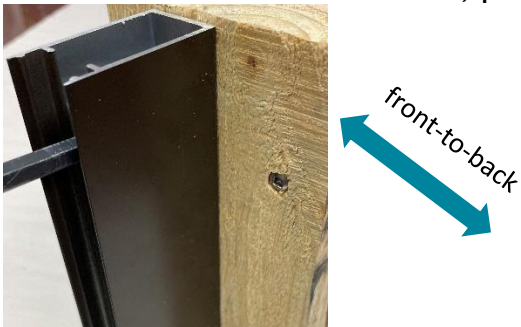

iii) Attach sashes at **end** of installation.

2) Install housing back

a) Pre-drill a 3/8" hole through the housing as far from the **rolled screen as possible** to ensure the cord will not interfere with operation. The cord may also run inside a track and out a drilled hole at the bottom of the track.



b) Pre-drill mounting holes through bracket holes, then 24" O/C in pairs.

c) Fasten at ends and middle first, ensuring **level**. Then through remaining holes. Shim where necessary.



3) Install rolled screen

a) If not done yet, attach spring ring onto crown.

Spring ring

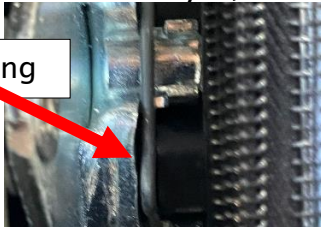

b) Insert the pivot.

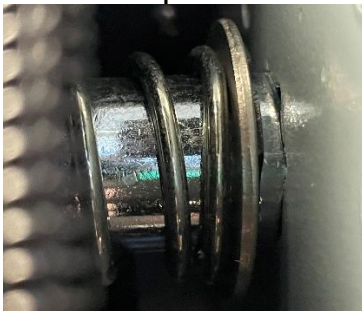

c) As lifting rolled screen into place, feed cord through hole, compress pivot end, and insert motor end into crown. ***There must be a distinct "CLICK" sound and feel.**

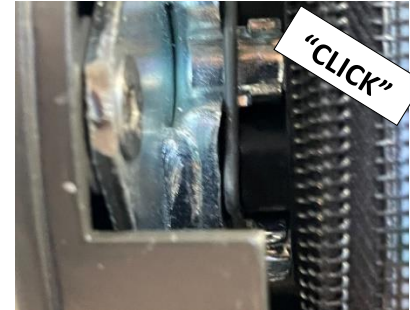
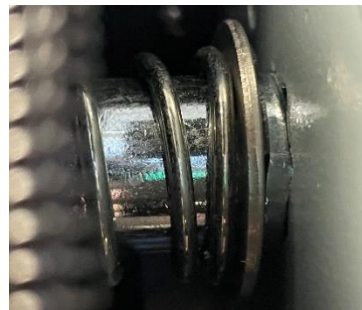

4) Somfy Maestria 500 Series Motor programming

a) Attach plug to cord per provided instructions. Plug into outlet.



*If hardwiring, consult with electrician. See “Maestria 50 RTS Specs (for electricians)” on Wizard [tech page](#).

b) Program screen limits **roughly** (recommended).

- i) See “Remote Programming – Quick Reference Guide” on [tech page](#).
- ii) You may need to assist screen by holding each end as it comes down.
- iii) You will precisely set limits at the end.



5) Install bottom-bar

a) Send screen to comfortable height.



b) Fold tab up and feed bottom-bar along zipper.



c) Manually screw probes onto tabs until they pinch fully. ***Do not over-tighten screws.**

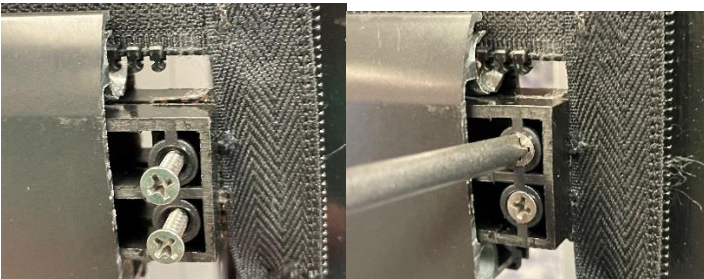

d) Flush seal at one end of slide-bar and cut excess off at other. Cut excess zippers off just beyond tabs.

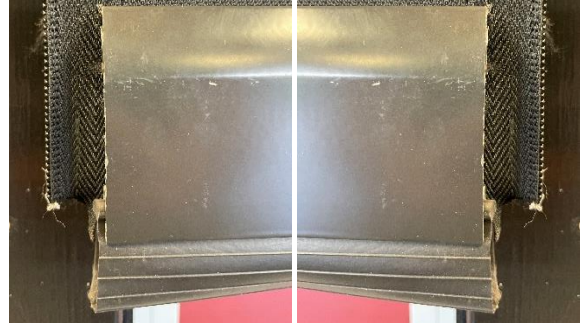

e) Send screen to upper limit, ensuring zipper stacks well.



6) Affix tracks

- a) Measure from horizontal lip to ground. Subtract 1/8" and **record**. If lengths are different, label tracks.
- b) Measure from square part of entry ends. Mark and cut tracks.



c) Starting with one track:

- i) Feed track along zipper.
- ii) Fasten top of track first (like shown).



- iii) Fasten remainder of track **straight** and **plumb** (notice laser). *If affixing 2"x2" angles to tracks, ensure fasteners are less than 1" and do not penetrate zipper grooves.

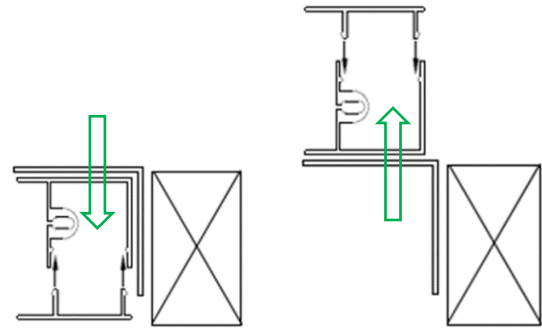

- d) Run the screen up and down, ensuring the zipper stacks well.

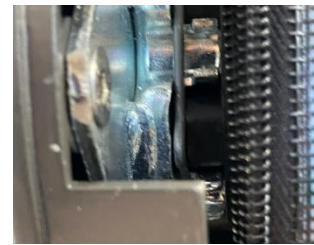

- e) Affix the other track.

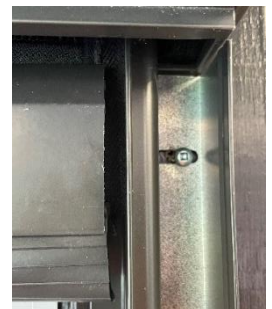

f) Ensure tracks are **parallel, plumb, and straight**.



Tape Measure

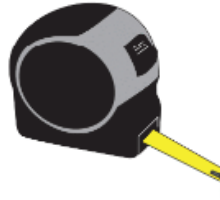

2-way Laser Level Kit



g) Spray dry silicone along the grooves.

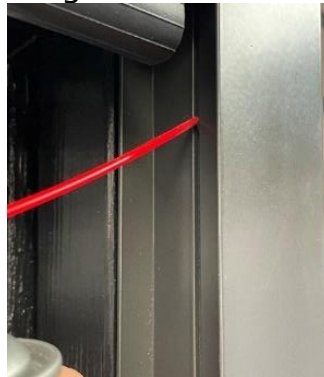

7) Fine-tune screen limits

a) Fine-tune the screen's upper and lower limits



i) See “Remote Programming – Quick Reference Guide” on [tech page](#).

ii) When establishing lower limit, depending on the screen material, allow a $\frac{1}{4}$ " - $\frac{1}{2}$ " gap. The screen will settle over time and close gap.

iii) If screen has a grade bias, it is typically desired that the bottom-bar be parallel with the housing at the upper limit. Stack strips of duct tape onto the roll-tube at the *higher* side until accomplished.



b) Ensure the following when operating:

- i) The zipper stacks on itself well.
- ii) Obstacle detection does not activate prematurely.
- iii) Zipper does not unzip from tracks.
- iv) Screen maintains trampoline like bounce.
- v) Bottom-bar remains centered.

8) Route Cord and Re-attach Plug

a) Remove plug from cord

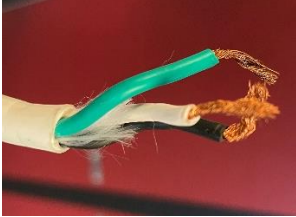

b) If cord is to follow inside track, drill a 3/8" hole at bottom of a track and feed cord through.



c) Route cord.



d) Cut cord to desired length.

- i) Do not cut cord within 18" of motor where the antenna lies.
- ii) Ensure there is enough cord to form a drip loop at plug end.



e) Attach plug to cord per provided instructions. Plug into outlet.



9) Finishing Touches

a) Attach housing cover.

Top



Bottom



b) Mallet track covers onto tracks.

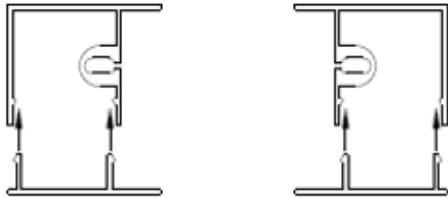

c) If applicable, mallet sashes onto 2"x1" box channels.



d) Affix the wall mount for the remote **inside** because the remote is sensitive to moisture (IP 30 rating). Hang remote.



See "Homeowner Training and DO's & DON'Ts" on [tech page](#).

Details and specifications subject to change