

# SmartScreen Motorized

## Standard

### Comprehensive Guide



## Contents

Recommendations & Resources .....	3
Preliminary Planning .....	4
Measurements .....	6
Ordering Process .....	9
Field Preparation .....	12
Installation .....	14
1) “Reveal Fit” Backing Options .....	14
2) Install Housing Back .....	14
3) Install rolled screen .....	16
4) Motor Programming .....	17
5) Install Bottom-Bar .....	18
6) Affix Tracks .....	19
7) Fine-tune Screen Limits .....	21
8) Route Cord and Re-attach Plug .....	22
9) Finishing Touches .....	23

## Recommendations & Resources

1. [Read this guide before first installation.](#)

2. Bookmark links:

[Technical Resources | Wizard Screens | Premium Retractable Screens for Doors, Windows and Large Openings](#)

[Install Guides | Wizard Screens | Premium Retractable Screens for Doors, Windows and Large Openings](#)

**\*Details and specifications subject to change. Review regularly.**

3. Learn about Somfy Maestria 50 RTS and Alpha WSER50 30/21 motors.



Up-to-date “Supplier Resources” available in marketing tab via [Wizard Screens & Shades Order Portal](#)

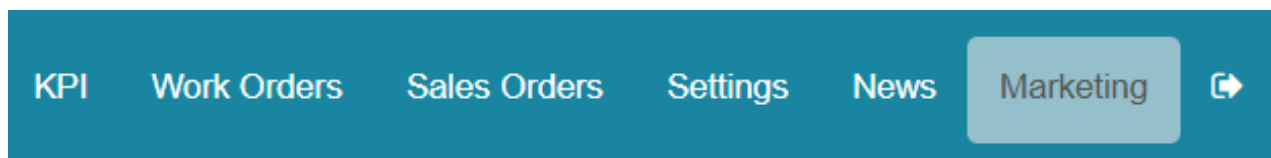

**DO NOT PROCEED WITH INSTALLATION BEFORE COMPLETING ABOVE ITEMS.**

4. Call 1-888-949-3667
- to schedule an installation training session
  - if problems arise during installation

### Preliminary Planning

Min. width	= 3' 2"
Max. width	= 30'
Max. width (vinyl)	= 25'
Min. height	= 3'
Max. height	= 16'

1) Determine the installation type.

a) **Reveal Fit** – Unit mounted *under* header and *inside* jambs.

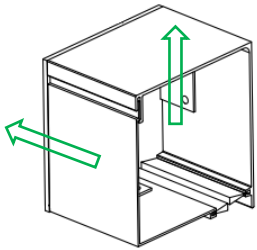

Tracks mounted to:

i) 2"x2" Angle Channels

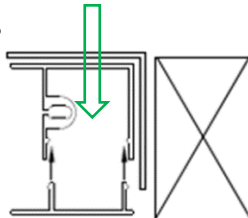
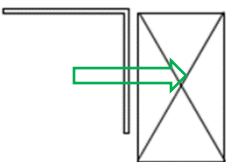

**OR**

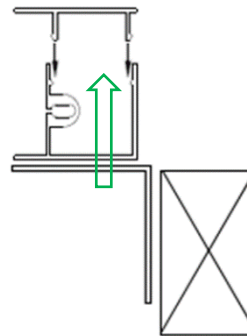

ii) 2"x1" Box Channels



b) **Face Fit** – Unit mounted onto *face* of header and jambs.

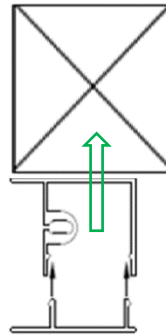
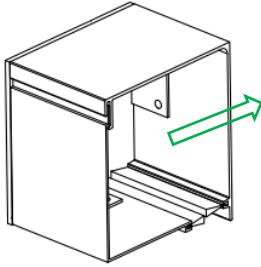

**\*NOTE:** Combination possible as installer sees fit.

### 2) Component & Sizing Table

Selectable					Dimensional Threshold	
Screen Material	Roll-tube	Housing	Motor	Idler	Width	Height
Mesh & Fabric	4"	5 ½"	Maestria 525 or WSER50 30/21	Standard 2 1/8"	38" to 22'4"	& less than 12'
Mesh & Fabric	5 ⅜"	7"	Maestria 550	Double 7 ¼"	22' 4" to 30'	& 12' to 16'
Vinyl	See "Dim. Thresh."		Maestria 550	See "Dim. Thresh."	3' 2" to 25'	Up to 16'

**\*NOTE:** If size is *beyond* threshold in first row, some/all of first row items will *not* be selectable.

For more details, see step 5 "ORDERING PROCESS"

### 3) Graded floor (I.e., sloped patio)

- It can be requested the screen be cut at the bottom to a maximum 1 ½" grade.
- Mohair can accommodate an extra 1" grade.

**\*\*\*HOUSING MUST BE LEVEL!\*\*\***

## Measurements

### 1) Tools required:

Tape Measure

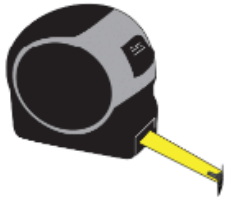

Pencil



2-way Laser Level Kit



Laser Distance Measure



### 2) Establish **plumb** & **level** marks. Then determine dimensions.

\* The industry standard “3-width-measurements method” will *not* work most effectively for most cases.

**\*\*Unit must be measured for and established plumb, level, parallel, and square. It is likely the opening will not have all of these attributes. For reveal fit applications, it is especially important to not measure a unit's width too large.**

The “opening” illustrations are *exaggerated* to provide clarity.

 = opening

 = future screen

In-Jamb Fit

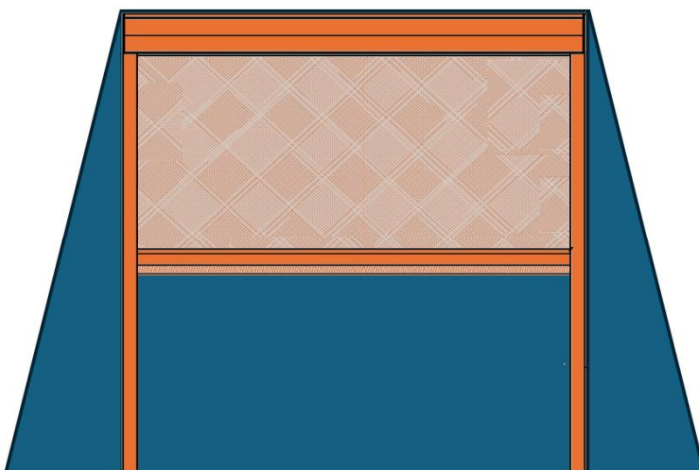

Face Fit

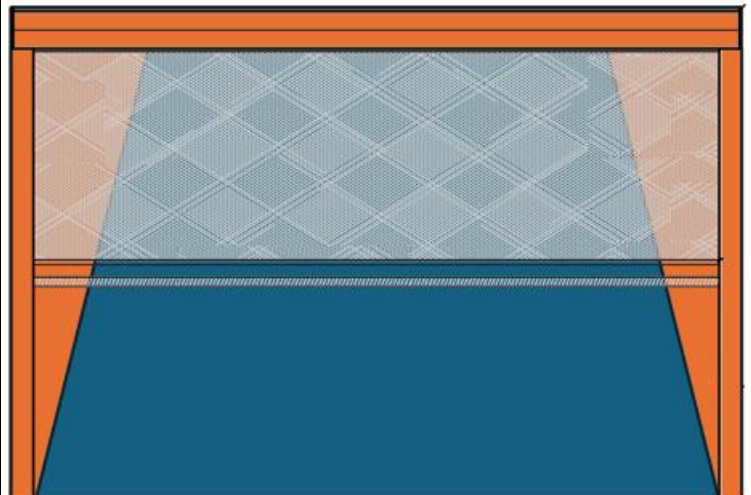

In-Jamb Fit

Face Fit

Standard

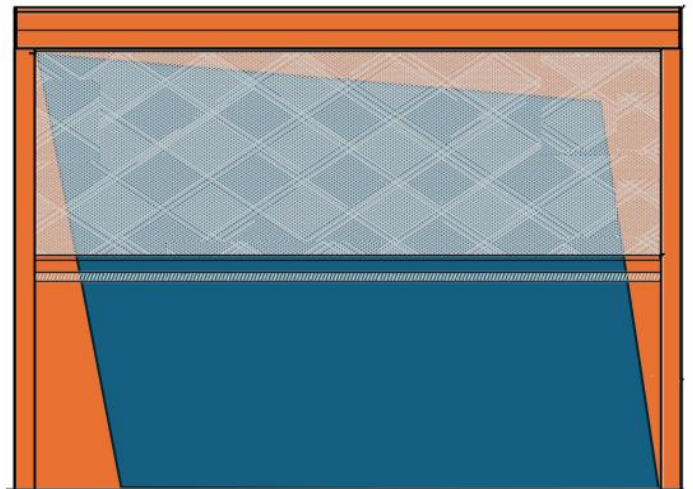
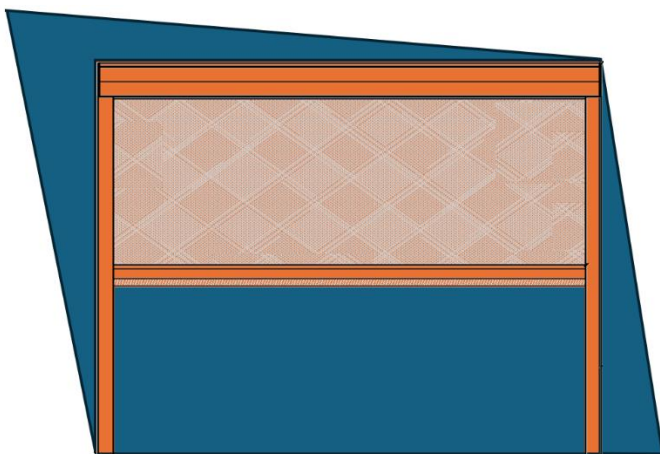
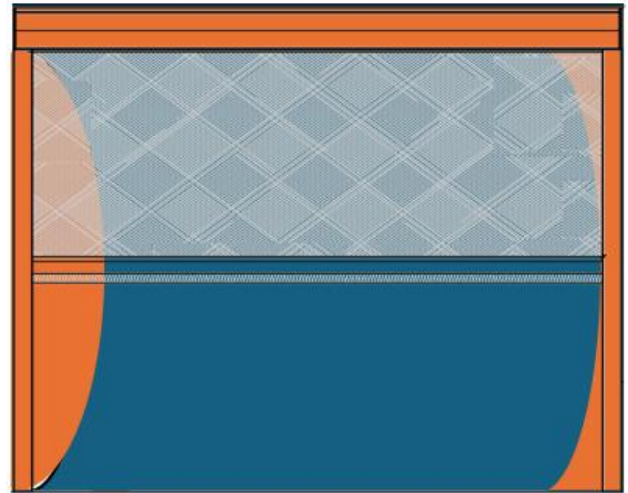
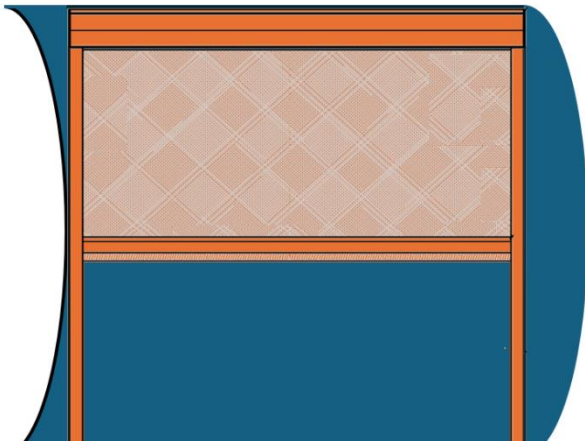
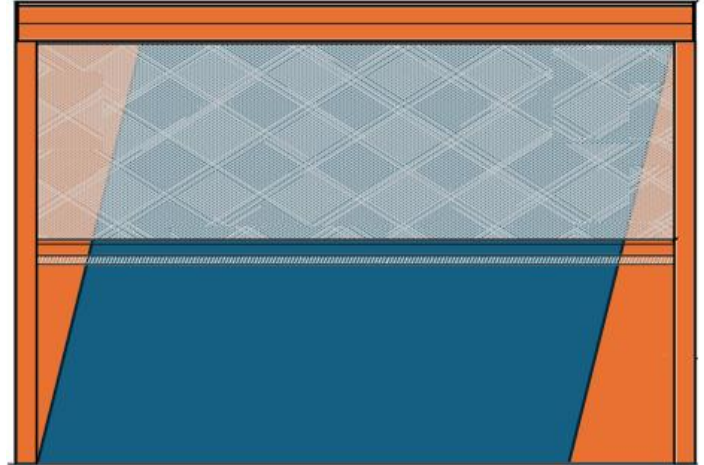
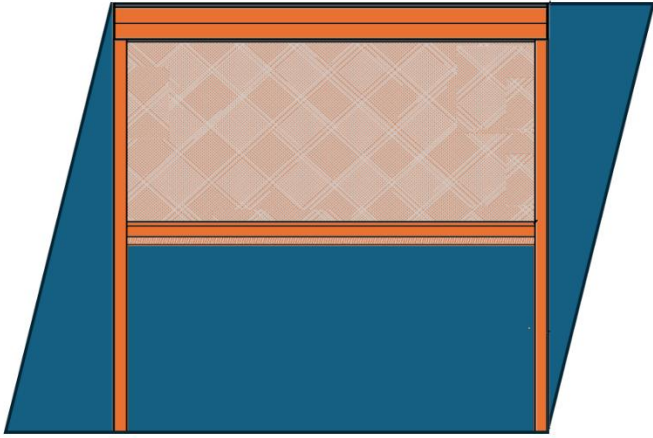

3) **Minimum Deductions & Additions**

a) **In-Jamb Fit - Width**

- i. 2"x2" Angle Channel  
 $\frac{1}{8}" + \frac{1}{8}"$  Angles thickness  
 $+ \frac{1}{8}"$  Safety

=  $-\frac{3}{8}"$  **Width Deduction**

**(from plumb marks)**



- ii. 2"x1" Box Channel

$\frac{1}{8}"$  Safety  
 =  $-\frac{1}{8}"$  **Width Deduction**

**(from plumb marks)**



b) **Face Fit - Width**

- i. Tracks  
 $1\frac{7}{8}" + 1\frac{7}{8}"$  Track Widths

≈ **+4" Width Addition**

c) **Height**

- i. Record **largest** height measurement from **top of future-housing to floor**.  
 ii. If floor is *graded*, measure from **top of future housing to floor** at **left** and **right** sides. Record both measurements.  
 \* It can be requested the screen be cut at the bottom to a **maximum 1 ½" grade**.  
 \*\*Mohair can accommodate an **extra 1" grade**.

**\*\*\*HOUSING MUST BE LEVEL!\*\*\***

## Ordering Process

### 1) Dimensions

Min. width	= 3' 2"
Max. width	= 30'
Max. width (vinyl)	= 25'
Min. height	= 3'
Max. height	= 16'

### 2) Colours of Components

Latest offerings: [Screens for Doors, Patio, Window, Deck Spaces - Built Better | Wizard Screens](#)

### 3) Bottom-bar Seals

- Mohair
- Rubber (necessary if adding extra weight & with vinyl)

### 4) Screen Material

Latest offerings: [Screens for Doors, Patio, Window, Deck Spaces - Built Better | Wizard Screens](#)

\*See [Clear Vinyl Minimum Dimensions & Colours - Technical Resources](#)

\*\* Necessity of a seam is dependent on **screen material roll widths**. Request from your Wizard Sales Rep.

### 5) Motor Side

a) Select side as if looking at **front** unit, imagining how it will be oriented.

b) Select power cable **type** and **length**

\*Somfy Antennae within 18" of motor end. **Do not cut!**

\*\*If hardwiring, consult with electrician. See available motor technical specifications: [Technical Resources](#).

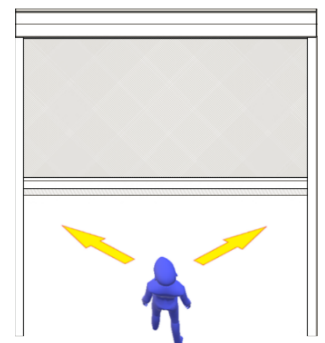

## 6) Component Table

Selectable					Dimensional Threshold	
Screen Material	Roll-tube	Housing	Motor	Idler	Width	Height
Mesh & Fabric	4"	5 ½"	Maestria 525 or WSER50 30/21	Standard 2 1/8"	3' 2" to 22' 4"	& less than 12'
Mesh & Fabric	5 ¾"	7"	Maestria 550	Double 7 ¼"	22' 4" to 30'	& 12' to 16'
Vinyl	See "Dim. Thresh."		Maestria 550	See "Dim. Thresh."	3' 2" to 25'	Up to 16'

**\*NOTE: If size is *beyond* threshold in first row, some/all first row items will *not* be selectable.**

If the project has multiple openings of varied sizes, and some require the larger size unit, consider the following:

a) **Retraction speed:**

Assume some smaller openings only require **4" roll-tubes** and some larger openings require **5 ¾" roll-tubes**. Consider a 4" roll-tube will retract faster than a 5 ¾" roll-tube.

- Order 7" housings, 5 ¾" roll-tubes, and Somfy Maestria 550 motors for *all* units.

b) **Aesthetics:**

Assume larger openings require 7" housings and smaller openings only require 5 ½" housings.

- Order 7" housings for *all* units.

c) If both **retraction speed** and **aesthetics** are important with above assumptions:

- Order 7" housings, 5 ¾" roll-tubes, and Somfy Maestria 550 motors for *all* units.

## 7) Remote Controls and Accessories

Refer to [SmartScreen Motorized Overview](#)

**\*Note: It's recommended an installer carry a 1 channel remote dedicated to programming.**

a) The effectiveness of remotes is subject to:

- i) Distance (**should be within 30' of motor**)

ii) Physical obstructions (i.e., concrete, wood, drywall, windows, etc.).

iii) Wired and wireless devices (i.e., refrigerators, wifi extenders, etc.)

\*Multiple remotes may be necessary.

**\*Note: Relying *exclusively* on the wind sensor can cause screen to be in motion without first being checked for interference from debris/ acts of God, etc. Customer would use at own risk.**

**\*\*Obstacle detection is ON by default with *all* motors.**

8) Other special requests:

a) Seam location

\*Request mesh/fabric roll widths from your Wizard Sales Rep.

b) Accessories

c) Bias mesh cut if each side of unit is different height

d) Extra weight

i) Windy areas with fabric

ii) Clear-vinyl

## Field Preparation

Before installing the SmartScreen Motorized units

- 1) Tools Required:
  - a) Cordless drill
  - b) Step drill bit
  - c) Desired driver bits
  - d) Phillips screwdriver
  - e) 2-way laser level
  - f) Tape measure
  - g) Laser distance measure
  - h) Scissors
  - i) Needle nose pliers
  - j) Duct tape (if floor is graded)
  - k) Dry silicone spray
  - l) Caulking gun with desired colour caulk
  - m) Chop saw with non-ferrous blade
  - n) Concrete, metal, or wood fasteners. **Min. 2" long.**
  - o) Appropriate fasteners determined by material affixed to (e.g. lumber, metal, plywood, etc.) **Min. 2" long.**
  
- 2) Contents of Shipment per unit (may vary)
  - a) Assembled housing
  - b) Assembled rolled screen
  - c) Bottom-bar with seal
  - d) Probes (x2)
  - e) Tracks (x2)
  - f) Remote(s)Optional:
  - g) 2"x2" angles (x2)
  - h) 2"x1" box channels (x2)
  
- 3) Package and unit visual inspection
  - a) If **packages** are damaged, **unit** may still be free of damage.  
**Regardless, you must mark external damage on waybill.**
  - b) Report any potential damage to Wizard Screens **immediately** with pictures.

#### 4) Unpackaging

- a) *Carefully* unpackage contents. **Do not cut screen! Do not scratch components!**



- b) Report any visible damage to Wizard Screens ***immediately*** with pictures.

- c) Detach housing cover. Set that and screws aside.

- d) Remove spring ring from crown.



- e) Compress pivot end until motor end comes free from crown, then remove.

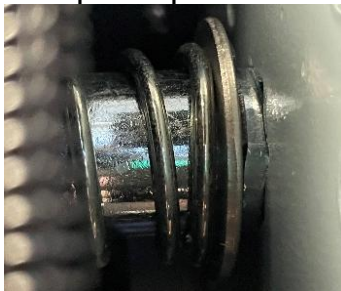

- f) Re-attach spring ring onto crown.

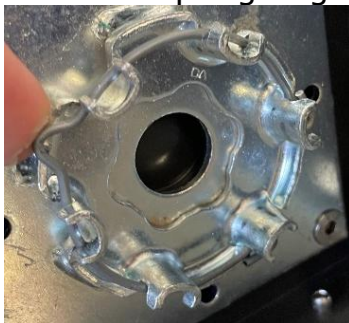

### Installation

\*Minimum 2 people recommended.

#### 1) "Reveal Fit" Backing Options

##### a) Install 2"x2" angle channels:

- i) Cut angles to desired lengths.
- ii) Pre-drill and countersink holes 2" from top and bottom. Then continue 48" O/C.
- iii) Fasten angles to surface using flatheads, plumb front-to-back.

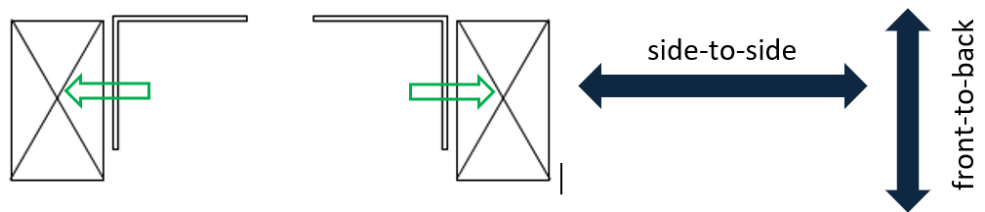

##### b) Install 2"x1" box channels:

- i) Cut box channels to desired lengths.
- ii) Fasten box channel to surface, plumb front-to-back.

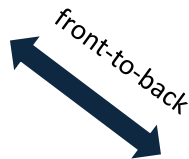

- iii) Attach caps at *end* of installation.

#### 2) Install Housing Back

##### a) Feeding motor cord:

##### i) Somfy cord

Pre-drill a 3/8" hole through housing away from end of rolled screen to ensure cord will not interfere with operation; OR feed along inside of track and out drilled hole at bottom.



OR



#### ii) Alpha cord

Outlet at top:  
5/8" hole



**OR**

Outlet at bottom: Feed cord through bottom of track and along inside.



Use heat-gun to shrink sleeve onto pig-tail connection.

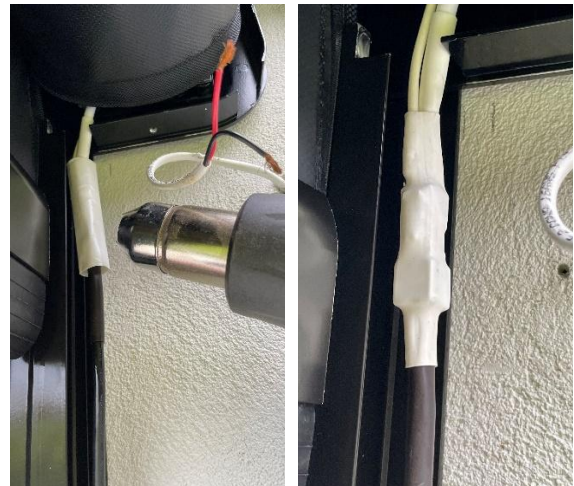

b) Pre-drill mounting holes through bracket holes, then 36" O/C in pairs.

c) Fasten at ends and middle first, ensuring level. Then through remaining holes. Shim where necessary.



### 3) Install rolled screen

a) If not done yet, attach spring ring onto crown.

Spring ring



b) Insert the pivot.



c) As lifting rolled screen into place, feed cord through hole, compress pivot end, and seat motor end into crown. **\*There must be a distinct "CLICK" sound.**

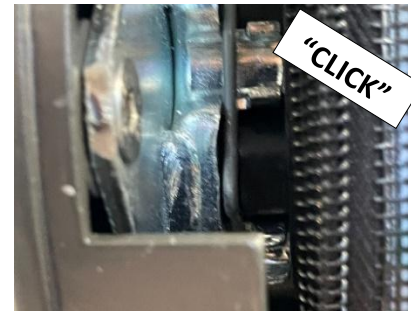
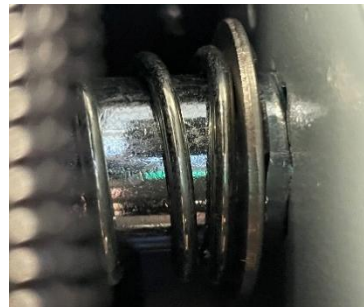

**\*For Alpha motors, put spring ring onto crown after rolled screen is seated.**

#### 4) Motor Programming

a) Attach plug to cord per provided instructions. Plug into outlet.



\*If hardwiring, consult with electrician. [See motor technical specifications: Technical Resources.](#)

b) Program screen limits **roughly** (recommended).

- i) See remote programming guides: [Install Guides.](#)
- ii) You may need to assist screen by holding each end as it comes down.
- iii) You will precisely set limits at the *end*.



#### 5) Install Bottom-Bar

a) Send screen to accessible height.



b) Feed bottom-bar along zipper.



c) Manually screw probes onto tabs until they pinch fully.

**\*Do not over-tighten screws lest probes expand. Must have free movement within bottom bar.**

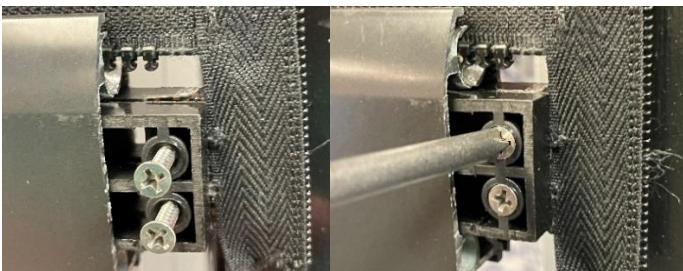

d) Flush seal at one end of bottom bar and cut excess off at other. Cut excess zippers off just beyond tabs.

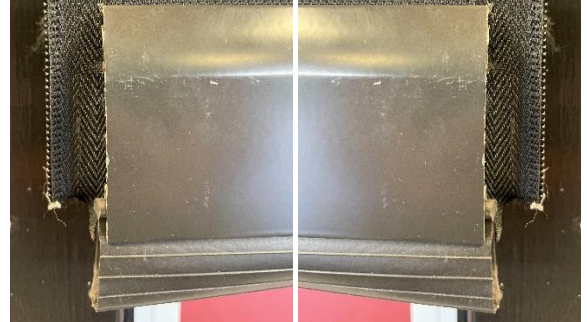

e) Send screen to upper limit, ensuring zipper stacks well.

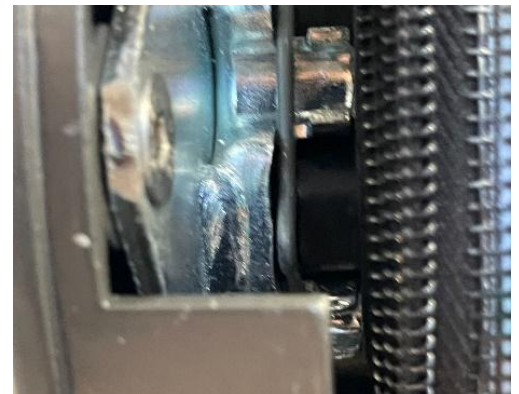

#### 6) Affix Tracks

- a) Measure from horizontal lip to ground. Subtract 1/8" and **record**. If lengths are different, label tracks.
- b) Measure from square part of entry ends. Mark and cut tracks.



- c) Starting with one track:
  - i) Feed track along zipper.
  - ii) Fasten top of track *first* (like shown).



- iii) Fasten remainder of track **straight** and **plumb** (notice laser).  
\*If affixing 2"x2" angles to tracks, ensure fasteners are less than 1" and do not penetrate zipper grooves.

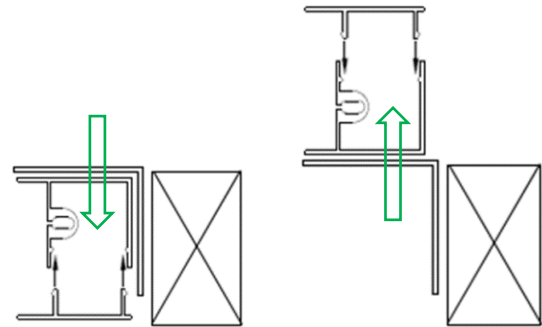

- d) Run screen up and down, ensuring the zipper stacks well.

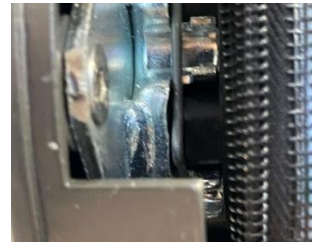

- e) Affix other track.



f) Ensure tracks are **parallel, plumb, and straight**.



Tape Measure

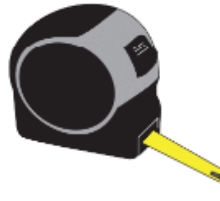

2-way Laser Level Kit



g) Spray dry silicone along zipper grooves.



### 7) Fine-tune Screen Limits

#### a) Fine-tune screen's upper and lower limits



i) See remote programming guides: [Install Guides](#).

ii) When establishing lower limit, depending on screen material, allow a ¼" - ½" gap. The screen will settle over time and close gap.

iii) If screen has a grade bias, it is typically desired that bottom-bar be parallel with housing at upper limit. Stack strips of duct tape onto roll-tube at *higher* side until accomplished.



#### b) Ensure the following when operating:

- i) Zipper stacks on itself well.
- ii) Obstacle detection does not activate prematurely.
- iii) Zipper does not unzip from tracks.
- iv) Screen maintains trampoline like bounce.
- v) Bottom-bar remains centered.

#### 8) Route Cord and Re-attach Plug

- a) Remove plug from cord

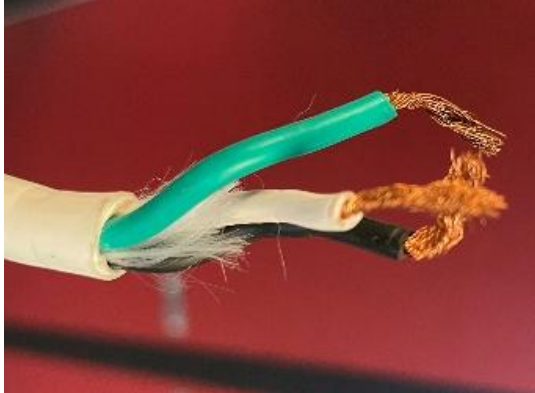

- b) If cord is to follow inside track, drill a 3/8" hole at bottom of a track and feed cord through.



- c) Route cord.



- d) Cut cord to desired length.  
i) \*If using Somfy, do not cut cord within 18" of motor where the antenna lies.  
ii) Ensure there is enough cord to form a drip loop at plug end.



- e) Attach plug to cord per provided instructions. Plug into outlet.



### 9) Finishing Touches

a) Attach housing cover.

Top (if applicable)



Bottom



b) Mallet track caps onto tracks.

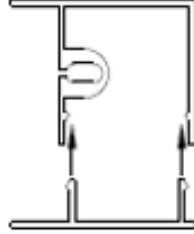
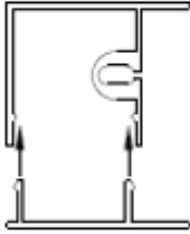

c) If applicable, mallet sashes onto 2"x1" box channels.



d) Affix remote mount and hang remote.



\*Somfy Telis 1 Channel shown

See [Homeowner Training](#)

Details and specifications subject to change